



METROLOGIC INSTRUMENTS, INC.
MS3780 Fusion™
Omni/Single Line Scanner
Installation and User's Guide



Copyright

© 2005 by Metrologic Instruments, Inc. All rights reserved. No part of this work may be reproduced, transmitted, or stored in any form or by any means without prior written consent, except by reviewer, who may quote brief passages in a review, or provided for in the Copyright Act of 1976.

Products and brand names mentioned in this document are trademarks of their respective companies.

TABLE OF CONTENTS

Introduction

Product Overview	1
Scanner and Accessories	2
Scanner Components	4
Caution and Serial Number Labels	5
Stand Specifications	5
Cable Removal	6
Cable Connection Warning	6
Maintenance	6

Installation

RS232 or Light Pen	7
IBM 46xx or OCIA	8
Keyboard Wedge	9
Stand-Alone Keyboard Wedge	10
Full Speed or Low Speed USB (Integrated)	11
EAS Deactivation	12

Scanner Operation

The Scan Pattern Mode Select Button	13
How to Use CodeGate and the Manual Activation Mode	14

Indicators

Audible	15
Visual	16
Failure	17

Depth of Field Specifications

Normal Scan Zone	18
Reduced Scan Zone	19

Depth of Field by Bar Code Element Width

Normal Scan Zone	20
Reduced Scan Zone	21

TABLE OF CONTENTS

IR Activation Range	
Normal	22
Reduced	22
Troubleshooting Guide	23
Design Specifications	27
Applications and Protocols	29
Default Settings - Communication Parameters.....	30
Upgrading the Flash ROM Firmware	35
Scanner and Cable Terminations	36
Laser and Product Safety	40
Limited Warranty	42
Patents	43
Index	44

INTRODUCTION

The Fusion is a hand-held, omnidirectional bar code scanner with optional single-line scanning capabilities. It utilizes the powerful Metrologic QuantumE scan engine to provide an outstanding scan performance on all standard 1D barcode symbologies, including RSS. Designed for retail applications, the Fusion includes additional key product features like:

- Fully Automatic Scanning Operation
- Single-Line Mode for Menu Reading
- Custom Configurable Scan Pattern
- User-Replaceable Single-Cable Interface to Host (PowerLink Compatible)
- User Configurable Depth of Field
- Easy Bar Code Configuration
- Data Editing
- 7 Beeper Tones
- Flash - Upgradeable Firmware
- OPOS and JPOS System Compatible
- CodeGate[®]
- Sunrise 2005 Compliant

SCANNER	INTERFACE
MS3780-9	OCIA and RS232 Transmit/Receive
MS3780-11	IBM 46xx and Full RS232
MS3780-38	RS232 Low Speed USB*, Keyboard Emulation Mode or USB Serial Emulation Mode
MS3780-40	Full Speed USB
MS3780-41	RS232/Light Pen Emulation
MS3780-47	Keyboard Wedge, Stand-Alone Keyboard and RS232 Transmit/Receive
MS3780-48	Stand Alone Keyboard and RS232 Transmit/Receive

* Configurable for Keyboard Emulation Mode or Serial Emulation Mode.
The default setting is Keyboard Emulation Mode.

Scanner and Accessories

BASIC KIT COMPONENTS	
Part No.	Description
MS3780	Fusion Scanner
00-02099	MS3780 Installation and User's Guide *
00-02407	MetroSelect® Configuration Guide *

* Guides also available for download at www.metrologic.com.

OPTIONAL ACCESSORIES	
Part No.	Description
AC to DC Power Transformer - Regulated 5.2VDC @ 650 mA output.	
45-45593	120V United States and Canada
45-45591	220V-240V Continental European
45-45592	220V-240V United Kingdom
46-46803	250V Australia
46-46983	250V China
The following cables are for Fusion models not equipped with EAS.	
53-53000.x-3	RS232 PowerLink Cable with Built in Power Jack 2.7 m (9 ft.) coiled cord, long strain relief, black
53-53002.x-3	Keyboard Wedge PowerLink cable with Adapter Cable 2.7 m (9 ft.) coiled cord, long strain relief, black
53-53020.x-3	Stand Alone Keyboard PowerLink Cable 2.7 m (9 ft.) coiled cord, long strain relief, black
MVC-3MPC-IB9	Metrologic Voltage Converter Cable, ±12VDC to +5.2VDC For IBM Applications
MVC-3MNC-N7052	Metrologic Voltage Converter Cable, ±12VDC to +5.2VDC For OCIA Applications

Other items may be ordered for the specific protocol being used. To order additional items, contact the dealer, distributor or call Metrologic's customer service department at 1-800-436-3876.

Scanner and Accessories

OPTIONAL ACCESSORIES	
Part No.	Description
53-53213.x-N-3	USB Full Speed Cable, Locking Plus-Power™ Type A 3 m (10 ft.) straight cord, short strain relief
53-53214.x-N-3	USB Full Speed Cable, Locking Plus-Power™ Type A 5 m (17 ft.) straight cord, short strain relief  This cable is for use with full speed USB (-40) interface only.
53-53235.x-N-3	USB Low Speed Communication Cable, Type A (Non-Locking) Connector 2.8 m (9.2 ft.) straight cord, short strain relief
The following cables are for Fusion models equipped with EAS.	
55-55000.x-E-3	RS232 PowerLink Cable with Built in Power Jack and EAS Connection Wire (1 ft.) 1.8 m (6 ft.), long strain relief, straight cable, black
55-55006.x-E-3	IBM PowerLink Cable with Built in Power Jack and EAS Connection Wire (1 ft.) 1.8 m (6 ft.), long strain relief, straight, black
46-00225	Stand

Other items may be ordered for the specific protocol being used. To order additional items, contact the dealer, distributor or call Metrologic's customer service department at 1-800-436-3876.

Scanner Components

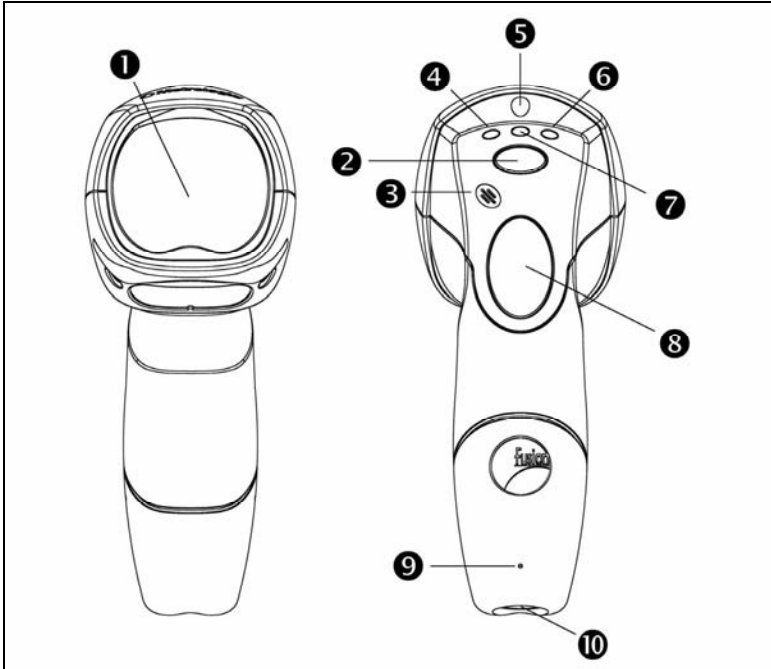

Figure 1. Scanner Components

ITEM No.	DESCRIPTION
1	Red Output Window, Laser Aperture (See page 40)
2	Mode Select Button (See page 13)
3	Beeper (See page 15)
4	Blue LED, Single-Line Mode / Menu Reading (See page 15)
5	White LED (See page 15)
6	Blue LED, All Scan Lines On / Omnidirectional Reading (See page 15)
7	Amber LED, CodeGate (See page 15)
8	CodeGate Button (See page 14)
9	Pin Hole for Cable Release (See page 6)
10	10-Pin RJ45, Female Socket (See page 36)

INTRODUCTION

Caution and Serial Number Labels

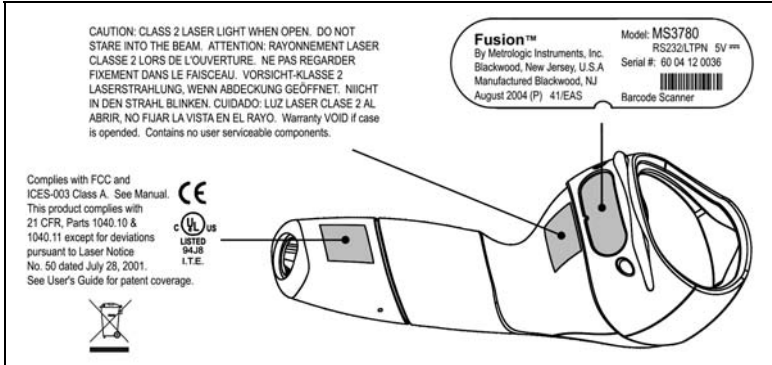

Figure 2. Caution and Serial Labels

Stand Specifications

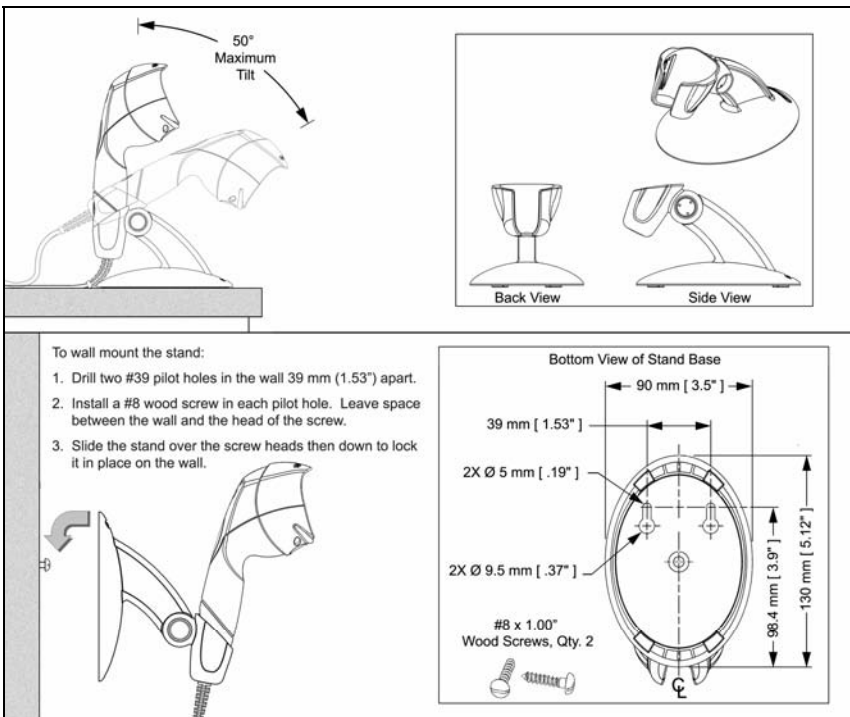

Figure 3. Stand Specifications

Introduction

Maintenance

Smudges and dirt can interfere with the proper scanning of a bar code. Therefore, the output window will need occasional cleaning.

1. Spray glass cleaner onto a lint free, non-abrasive cleaning cloth.
2. Gently wipe the scanner window.

Cable Removal

Disconnect the power supply from the PowerLink cable and turn off power to the host system before removing the cable from the scanner.

1. Locate the small 'pin-hole' beneath the Fusion logo on the front side of the scanner near the end of the handle.
2. Bend an ordinary paperclip into the shape shown above.
3. Insert the paperclip (or other small metallic pin) into the small 'pin-hole'. There will be a faint 'click' when the connector's lock releases.
4. Pull gently on the cable's strain-relief to remove the cable.

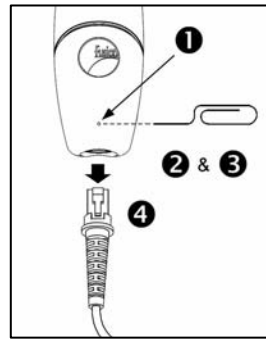

Figure 4.

Cable Connection Warning

i Important: If the PowerLink cable is not fully latched the unit can power intermittently.

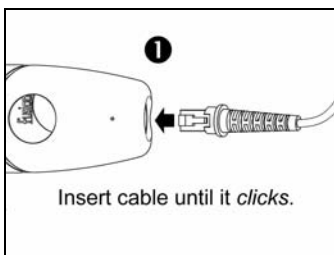

Figure 5.

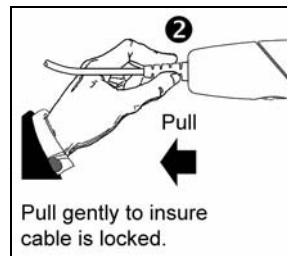

Figure 6.

RS232 or Light Pen

1. Turn off the host device.
2. Plug the male 10-pin RJ45 end of the PowerLink cable into the 10-pin socket on the MS3780.
3. Connect the 9-pin female end of the PowerLink cable to the appropriate communication port on the host device.
4. Plug the external power supply into the power jack on the PowerLink cable.



Check the AC input requirements of the power supply to make sure the voltage matches the AC outlet. The outlet must be located near the equipment and be easily accessible.

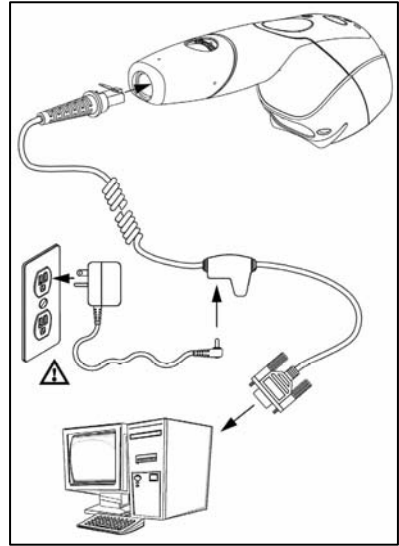

Figure 7.

5. Connect AC power to the transformer.
6. Turn on the host device.



When the scanner first receives power the white LED will flash, one blue LED will turn on and the scanner will emit one beep.



Plugging the scanner into the serial port of the PC does not guarantee that scanned information will appear at the PC. A software driver and correct configuration setting are also required for proper communication to occur.



Caution

To maintain compliance with applicable standards, all circuits connected to the scanner must meet the requirements for SELV (Safety Extra Low Voltage) according to EN/IEC 60950.

To maintain compliance with standard CSA C22.2 No. 60950/UL 60950 and norm EN/IEC 60950, the power source should meet applicable performance requirements for a limited power source.

INSTALLATION

IBM 46xx or OCIA

1. Turn off the host device.
2. Plug the male 10-pin RJ45 end of the MVC cable into the 10-pin socket on the MS3780.
3. For IBM:
Connect the other end of the MVC cable to Port 9 of the host device.

For OCIA:

Connect the other end of the MVC cable to the appropriate communication port on the host device.

4. Turn on the host device.

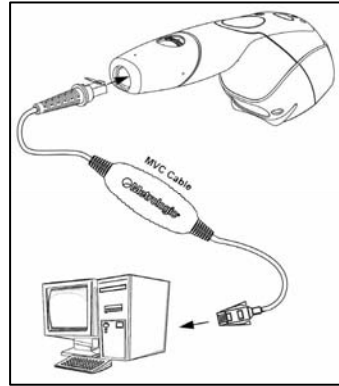
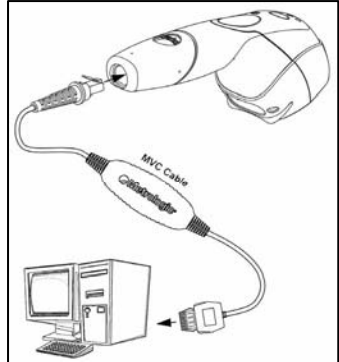

Figure 8. IBM (above), OCIA (below)



When the scanner first receives power the white LED will flash, one blue LED will turn on and the scanner will emit one beep.



Plugging the scanner into the serial port of the PC does not guarantee that scanned information will appear at the PC. A software driver and correct configuration setting are also required for proper communication to occur.



Caution:

To maintain compliance with applicable standards, all circuits connected to the scanner must meet the requirements for SELV (Safety Extra Low Voltage) according to EN/IEC 60950.

To maintain compliance with standard CSA C22.2 No. 60950/UL 60950 and norm EN/IEC 60950, the power source should meet applicable performance requirements for a limited power source.

INSTALLATION

Keyboard Wedge

1. Turn off the host device.
2. Plug the male 10-pin RJ45 end of the PowerLink cable into the 10-pin socket on the MS3780.
3. Disconnect the keyboard from the host device.
4. Connect the “Y” end of the PowerLink cable to the keyboard and the keyboard port on the host PC. If necessary use the male/female adapter cable supplied with the scanner for proper connections.
5. Plug the external power supply into the power jack on the PowerLink cable.



Check the AC input requirements of the power supply to make sure the voltage matches the AC outlet. The outlet must be located near the equipment and be easily accessible.

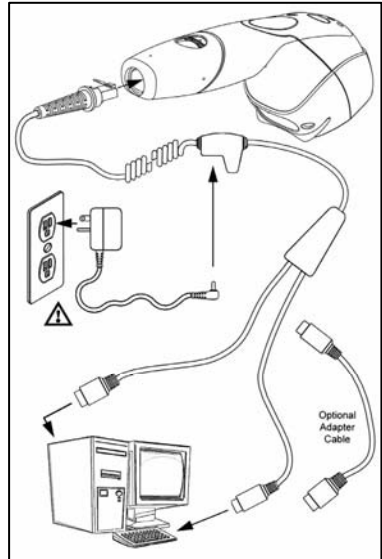

Figure 9.

6. Connect AC power to the transformer.
7. Turn on the host device.



When the scanner first receives power the white LED will flash, one blue LED will turn on and the scanner will emit one beep.



Powering the MS3780 directly from the host device can sometimes cause interference with the operation of the scanner or the computer. Not all computers supply the same current through the keyboard port. For this reason, Metrologic recommends using an external power supply. For additional information contact a Metrologic customer service representative.



Caution:

To maintain compliance with applicable standards, all circuits connected to the scanner must meet the requirements for SELV (Safety Extra Low Voltage) according to EN/IEC 60950.

To maintain compliance with standard CSA C22.2 No. 60950/UL 60950 and norm EN/IEC 60950, the power source should meet applicable performance requirements for a limited power source.

Stand-Alone Keyboard

1. Turn off the host device.
2. Plug the male 10-pin RJ45 end of the PowerLink cable into the 10-pin socket on the MS3780.
3. Connect the other end of the PowerLink cable to the keyboard port on the host device.
4. Plug the external power supply into the power jack on the PowerLink cable.



Check the AC input requirements of the power supply to make sure the voltage matches the AC outlet. The outlet must be located near the equipment and be easily accessible.

5. Connect AC power to the transformer.
6. Turn on the host device.

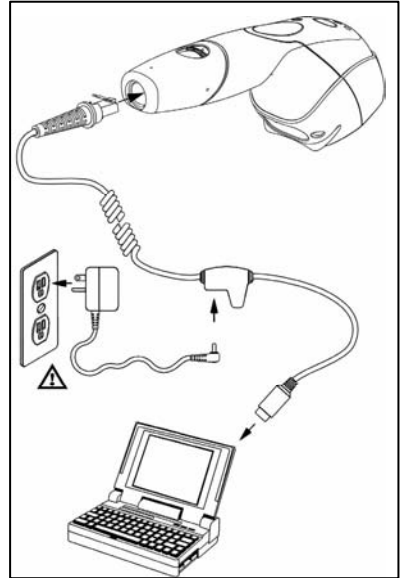

Figure 10.



When the scanner first receives power the white LED will flash, one blue LED will turn on and the scanner will emit one beep.



Powering the MS3780 directly from the host device can sometimes cause interference with the operation of the scanner or the computer. Not all computers supply the same current through the keyboard port. For this reason, Metrologic recommends using an external power supply. For additional information contact a Metrologic customer service representative.



Caution:

To maintain compliance with applicable standards, all circuits connected to the scanner must meet the requirements for SELV (Safety Extra Low Voltage) according to EN/IEC 60950.

To maintain compliance with standard CSA C22.2 No. 60950/UL 60950 and norm EN/IEC 60950, the power source should meet applicable performance requirements for a limited power source.

Full Speed or Low Speed USB (Integrated)

1. Turn off the host device.
2. Plug the male 10-pin RJ45 end of the USB PowerLink cable into the 10-pin socket on the MS3780.
3. Plug the other end of the USB interface cable into the host device's USB port.
4. Turn on the host device.

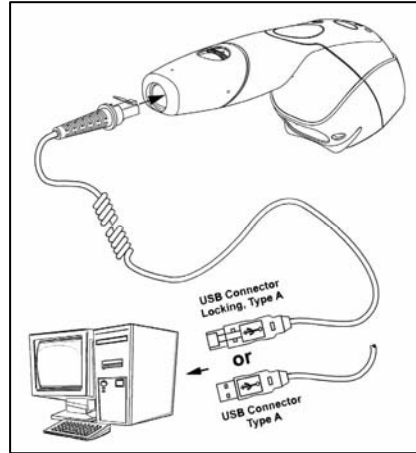

Figure 11.



As a default, the MS3780-38 leaves the factory with USB Keyboard Emulation Mode enabled.

For information on configuring the MS3780-38 for USB Serial Emulation Mode, please refer to the USB: Low Speed section of the MetroSelect Configuration Guide (MLPN 00-02407).



When the scanner first receives power the white LED will flash, one blue LED will turn on and the scanner will emit one beep.



Plugging the scanner into the USB port of the PC does not guarantee that scanned information will appear at the PC. A software driver and correct configuration setting are also required for proper communication to occur.



Caution:

To maintain compliance with applicable standards, all circuits connected to the scanner must meet the requirements for SELV (Safety Extra Low Voltage) according to EN/IEC 60950.

To maintain compliance with standard CSA C22.2 No. 60950/UL 60950 and norm EN/IEC 60950, the power source should meet applicable performance requirements for a limited power source.

EAS Deactivation

EAS DEACTIVATION

SW1 and SW2 are the switch banks inside the CheckPoint Device that set the deactivation range. The following is a list of CheckPoint recommended switch bank settings.

CheckPoint Recommended Switch Bank Settings
SW1 & SW2 switches 1 and 6 set to ON

All Fusion models equipped with EAS capabilities have an EAS designation in their model numbers. The cable supplied with these units will have additional wires for connection to the CheckPoint Device.

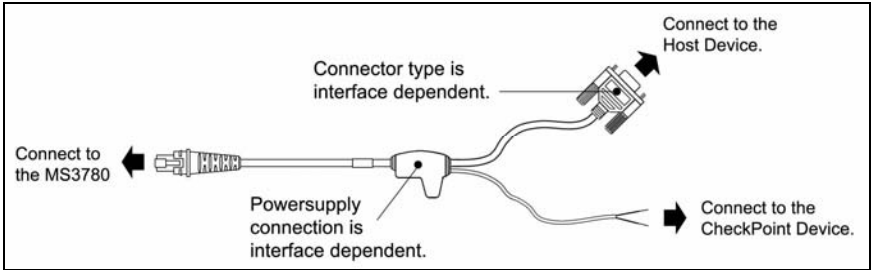

Figure 12. EAS Cable Connection (Bottom of StratosS)

Figure 13 shows the location of the EAS deactivation area for Fusion.

It is important to pass the entire tag through this area to deactivate the security tag.

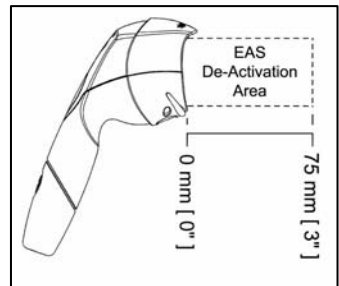

Figure 13. EAS Deactivation Area

The Scan Pattern Mode Select Button

There are two configurable scan pattern modes available with the MS3780.

- The **primary** scan pattern mode is the default scan pattern active when the scanner starts. By default, the primary scan pattern is set to all-scan-lines for omnidirectional reading.
- Pressing the scan pattern mode button (see figure below) activates the **secondary** scan pattern mode. By default, the secondary scan pattern is set to single-line mode for menu reading.



Please refer to the MetroSelect Configuration Guide for information on changing the default scan pattern settings.

To Change Scan Pattern Modes

1. To activate the secondary scan pattern, **press** and **release** the mode select button.

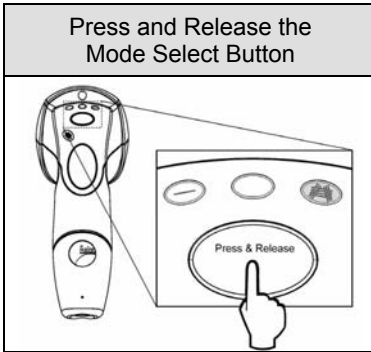

Figure 14.

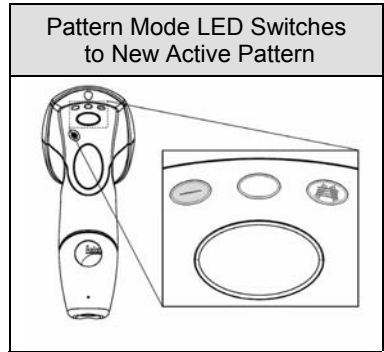

Figure 15.



Activating a pattern mode when the scanner is out of its stand does not change the in-stand pattern mode. When the scanner is returned to the stand it will automatically revert to the most recent scan pattern selected during in-stand operation.

2. To re-activate the primary scan pattern, **press** and **release** the mode select button again.

How to Use CodeGate and the Manual Activation Mode



For illustration purposes the unit's scan pattern has been set to *single-line (menu reading) mode*.

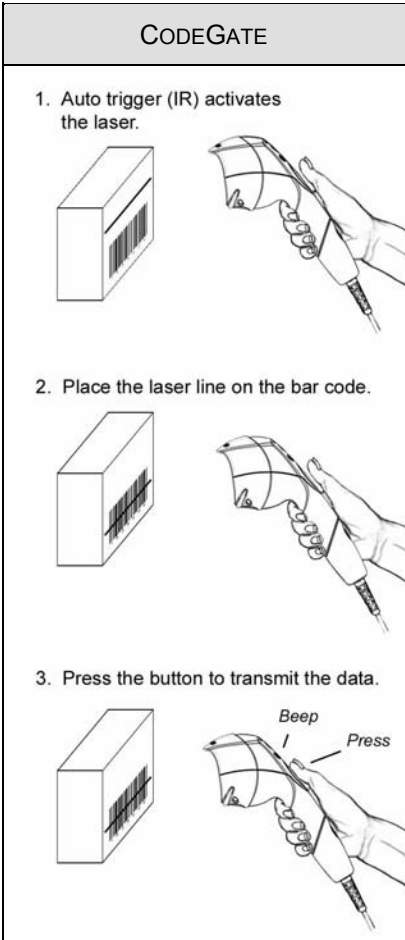

Figure 16.

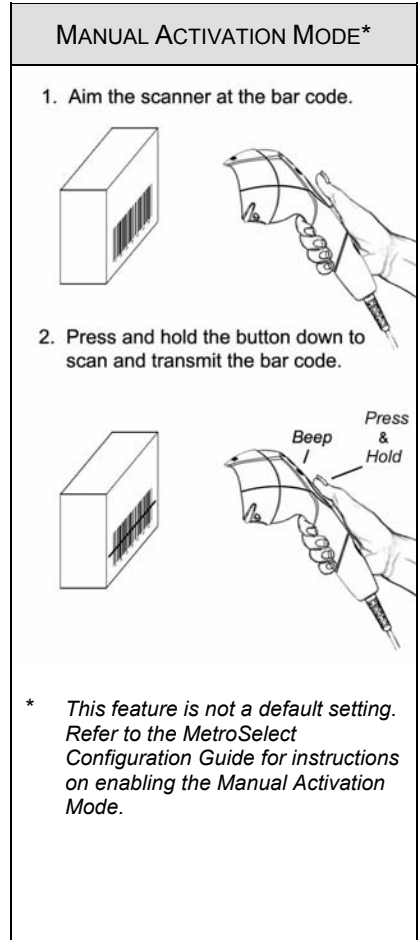

Figure 17.



Factory Defaults: In-Stand, CodeGate is not active (Amber LED is On)
Out-of-Stand, CodeGate is active (Amber LED is Off)

For information on how to change the factory defaults, refer to the MetroSelect Configuration Guide (00-02407).

Audible Indicators

When the MS3780 is in operation, it can provide audible feedback. These sounds indicate the status of the scanner. Eight settings are available for the tone of the beep (normal, 6 alternate tones and no tone). For instruction on how to change the tone of the beeper, refer to the MetroSelect Configuration Guide (00-02407).



One Beep

When the scanner *first* receives power; the white LED will flash, one blue LED will turn on and the scanner will emit a beep (*the white LED will remain on for the duration of the beep*). The scanner is now ready to scan.

When the scanner *successfully* reads a bar code, the white LED will flash and the scanner will emit one beep (*if configured to do so*). If the scanner does not emit one beep and the white light does not flash, then the bar code has *not* been successfully read.



Razzberry Tone

This is a failure indicator. Refer to *Failure Mode Indicators* on page 17.



Three Beeps - during operation

When placing the scanner in configuration mode, the white and blue LEDs will flash while the scanner emits three beeps. The white and blue LEDs will continue to flash until the unit exits the configuration mode. Upon exiting the configuration mode, the scanner will emit three beeps and the white LED will stop flashing.

When configured, 3 beeps can also indicate a communications timeout during normal scanning mode.

When using one-code-programming, the scanner will emit three beeps: the current selected tone, followed by a short pause then a high tone and a low tone. This tells the user that the single code configuration has *successfully* configured the scanner.



Three Beeps - on power up

This is a failure indicator. Refer to *Failure Mode Indicators* on page 17.

Visual Indicators

There are four LEDs located on the top of the MS3780. When the scanner is on, the flashing or constant illumination of the LEDs indicates the status of the current scan and the scanner.

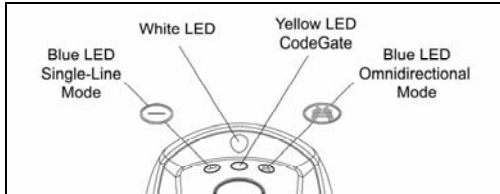

Figure 18. LED Indicators

No LEDs

The LEDs will not be illuminated if the scanner is not receiving power from the host or transformer. They are also not illuminated when all lasers are turned off for any reason.

Steady Blue Single-Line LED

Indicates the laser is active and the scanner is in Single-Line Mode. The blue LED will remain illuminated until the laser is deactivated.

Steady Blue Omni LED

Indicates the laser is active and the scanner is in the Omnidirectional Mode. The blue LED will remain illuminated until the laser is deactivated.

Steady Blue Single-Line or Omni LED and a Single White LED Flash

When the scanner successfully reads a bar code, the white LED will flash and the scanner will beep once. If the white LED does not flash or the scanner does not beep, then the bar code has not been successfully read.

Steady White and Blue Single-Line or Omni LED

After a successful scan, the scanner transmits the data to the host device. Some communication modes require that the host inform the scanner when data is ready to be received. If the host is not ready to accept the information, the scanner's white LED will remain on until the data can be transmitted.

Alternate Flashing of Both Blue LEDs and the White LED

This indicates the scanner is in program mode. A razzberry tone indicates that an invalid bar code has been scanned in this mode.

Steady Amber LED

Indicates that CodeGate is not active (in-stand default).

Failure Mode Indicators

Both Blue LEDs Flashing with One Emitted Razzberry Tone

This indicates that the scanner has experienced a laser subsystem failure. Return the unit to a Metrologic authorized service center for repair.

Both Blue LEDs and the White LED are Flashing with Two Emitted Razzberry Tones

This indicates that the scanner has experienced a motor failure. Return the unit to a Metrologic authorized service center for repair.

Continuous Razzberry Tone with Both LEDs Off - On Power Up

A continuous razzberry tone upon power up indicates there has been an electronic failure. Return the unit to a Metrologic authorized service center for repair.

Three Beeps - On Power Up

This indicates that the nonvolatile memory that holds the scanner configuration has failed. Return the unit to a Metrologic authorized service center for repair.

Depth of Field Specifications*

Normal Scan Zone

Specifications are based on a 0.33 mm (13 mil) bar code.

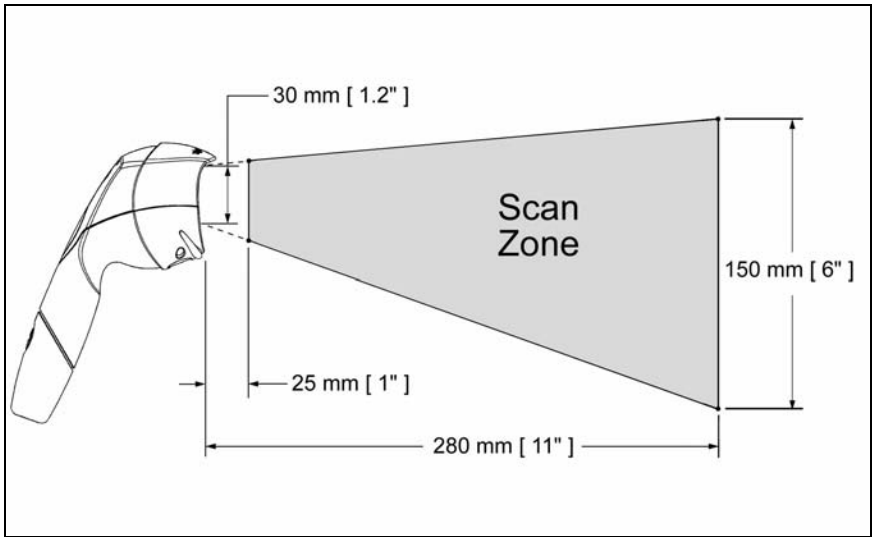

Figure 19. Normal Depth of Field

* All specifications are subject to change without notice.

Depth of Field Specifications*

Reduced Scan Zone

Specifications are based on a 0.33 mm (13 mil) bar code.

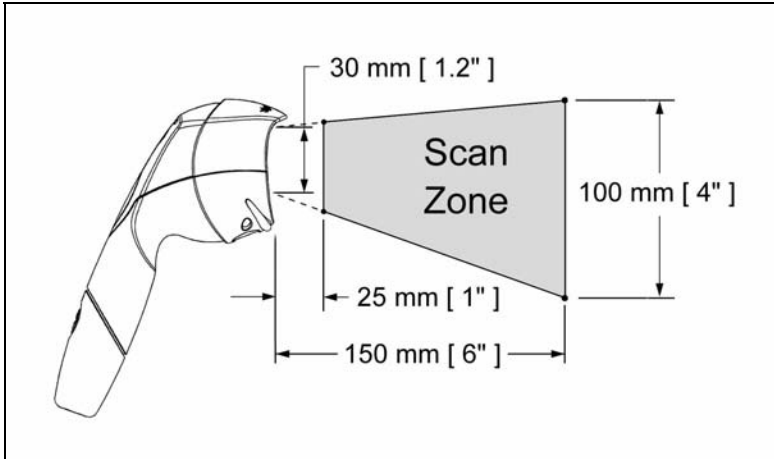

Figure 20. Reduced Depth of Field

* All specifications are subject to change without notice.

Depth of Field by Bar Code Element Width*

Normal Scan Zone

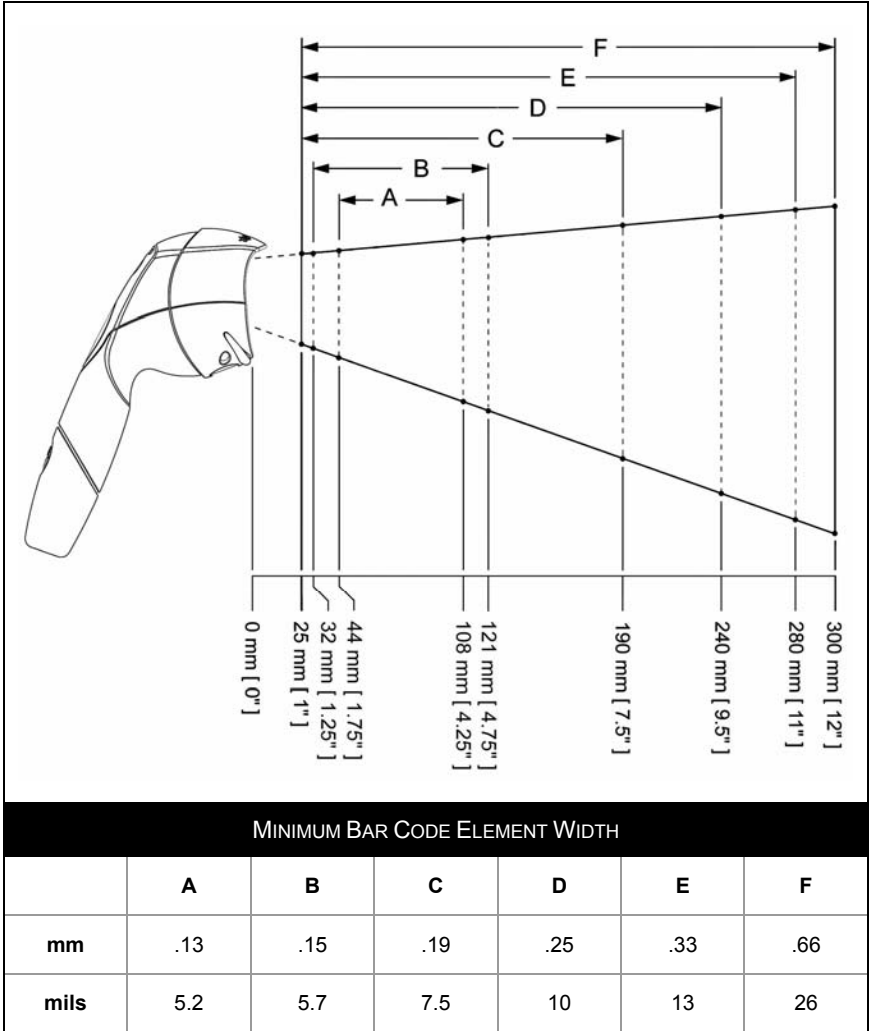

Figure 21. Normal Scan Zone by Bar Code Element Width

* All specifications are subject to change without notice.

Depth of Field by Bar Code Element Width*

Reduced Scan Zone

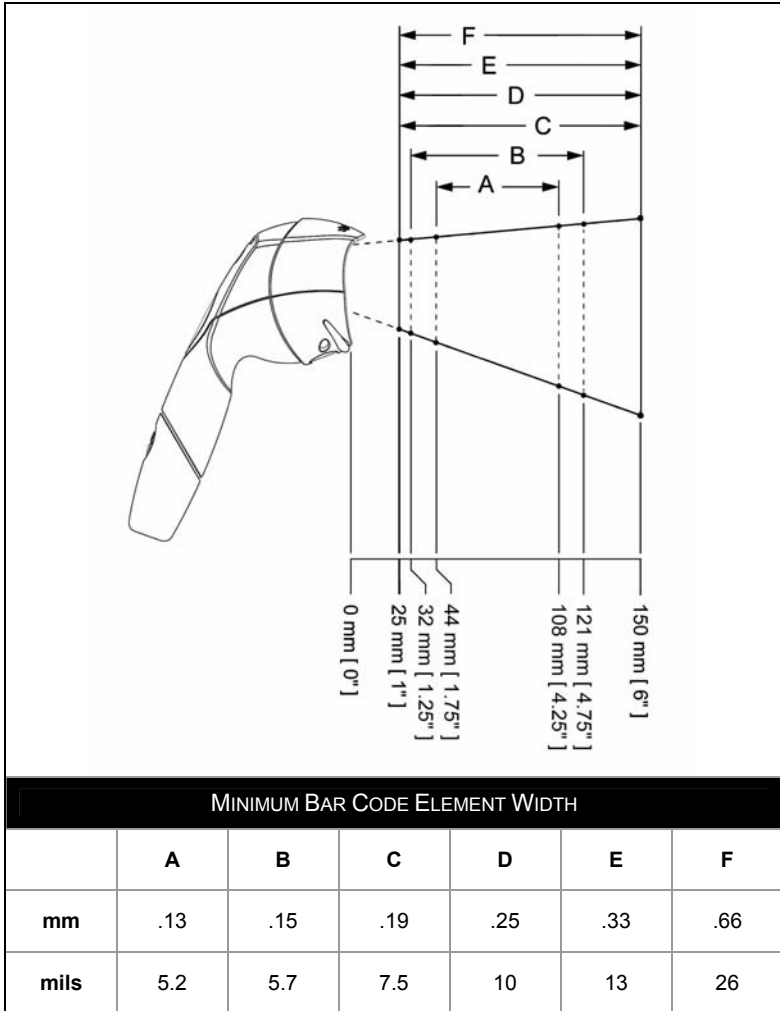

Figure 22. Reduced Scan Zone by Bar Code Element Width

* All specifications are subject to change without notice.

IR Activation Range*

Normal

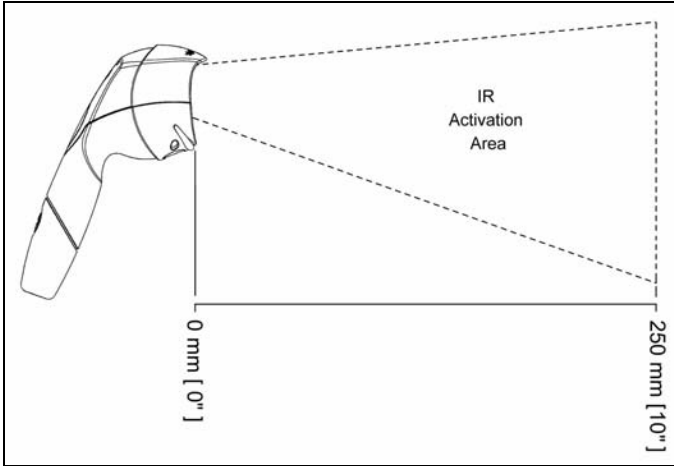

Figure 23. Normal IR Activation Range

Reduced

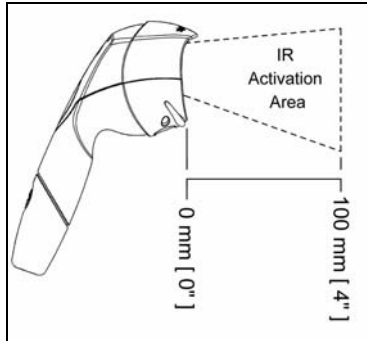

Figure 24. Reduced IR Activation Range

* All specifications are subject to change without notice.

TROUBLESHOOTING GUIDE

The following guide is for reference purposes only. Contact a Metrologic representative at 1-800-ID-METRO or 1-800-436-3876 to preserve the limited warranty terms on page 42.

Symptoms	Possible Cause(s)	Solution
<i>All Interfaces</i>		
The unit has no LEDs, beeper or motor spin.	No power is being supplied to the scanner.	Check the transformer, outlet and power strip. Make sure the cable is plugged into the scanner.
The unit has no LEDs and / or beeper.	No power is being supplied to the scanner from host.	Some host systems cannot supply enough current to power the MS3780. Use the power supply included with the scanner.
There are multiple scans upon presentation of code.	The same symbol timeout is set too short.	Adjust the same symbol timeout for a longer time increment.
The unit powers up but does not beep.	The beeper is disabled.	Enable the beeper.
	No tone is selected.	Select a tone.
The unit powers up but does not scan and/or beep.	The unit is trying to scan a particular symbology that is not enabled.	UPC/EAN, Code 39, Interleaved 2 of 5, Code 93, Code 128 and Codabar are enabled by default. Verify that the type of bar code being read has been selected
	The scanner has been configured for a character length lock, or a minimum length and bar code being scanned does not satisfy the configured criteria.	Verify that the bar code that is being scanned falls into the criteria. <i>Typical of Non-UPC/EAN codes. The scanner defaults to a minimum of 4 character bar code.</i>

TROUBLESHOOTING GUIDE

Symptoms	Possible Cause(s)	Solution
<i>All Interfaces</i>		
The unit scans a bar code, but locks up after the first scan (<i>the white LED stays on</i>).	The scanner is configured to support some form of host handshaking but is not receiving the signal.	If the scanner is setup to support ACK/NAK, RTS/CTS, XON/XOFF or D/E, verify that the host cable and host are supporting the handshaking properly.
The unit scans but the data transmitted to the host is incorrect.	The scanner's data format does not match the host system requirements.	Verify that the scanner's data format matches the format required by the host. Make sure that the scanner is connected to the proper host port.
Scanner beeps at some bar codes and NOT for others of the same bar code symbology.	The print quality of the bar code is suspect.	The type of printer and/or the printer settings could be the problem.
	The aspect ratio of the bar code is out of tolerance.	Check the print mode or change the printer settings. For example, change to econo mode or high speed.
	The bar code may have been printed incorrectly.	Check if it is a check digit, character or border problem.
	The scanner is not configured correctly for the type of bar code.	Check if check digits are set properly.
	The minimum symbol length setting does not work with the bar code.	Check if the correct minimum symbol length is set.

TROUBLESHOOTING GUIDE

Symptoms	Possible Cause(s)	Solution
<i>All Interfaces</i>		
During power up the unit beeps 3 times.	There is a non-volatile RAM failure.	Contact a Metrologic service representative.
During power up the unit razzes continuously.	There is a RAM or ROM failure.	Contact a Metrologic service representative.
During power up the unit razzes once and the blue LED flashes.	There is a VLD failure.	Contact a Metrologic service representative.
During power up the unit razzes twice and both LEDs flash.	There is a scanner motor failure.	Contact a Metrologic service representative.
<i>RS232 Only</i>		
The unit powers up OK and scans OK but does not communicate properly to the host.	The com port at the host is not working or is not configured properly.	Check to make sure that the baud rate and parity of the scanner and the communication port match and that the program is looking for RS232 data.
	The cable is not connected to the proper com port.	
	The com port is not operating properly.	

TROUBLESHOOTING GUIDE

Symptoms	Possible Cause(s)	Solution
<i>RS232 Only</i>		
The host is receiving data but the data does not look correct.	The scanner and host may not be configured for the same interface.	Check that the scanner and the host are configured for the same interface.
Characters are being dropped.	The intercharacter delay needs to be added to the transmitted output.	Add some intercharacter delay to the transmitted output by using the MetroSelect Configuration Guide (MLPN 00-02407).
<i>Keyboard Wedge Only</i>		
The unit scans the bar code but there is no data.	The unit may not be configured correctly.	Make sure the scanner is configured for the appropriate mode.
The unit scans but the data is not correct.	The unit may not be configured correctly.	Make sure that the proper PC type (ie. AT, PS2 or XT) is selected.
		Verify correct country code and data formatting are selected.
		Adjust the intercharacter delay.
The unit is not transmitting each character.	The unit may not be configured correctly.	Increase the interscan code delay setting. Adjust whether the F0 break is transmitted. It may be necessary to try both settings.
Alpha characters show as lower case.	The computer is in caps lock mode.	Enable <i>caps lock detect</i> setting of the scanner to detect whether the PC is operating in caps lock.
Everything works except for a couple of characters.	These characters may not be supported by the current country's key look up table.	Try operating the scanner in <i>Alt Mode</i> .

DESIGN SPECIFICATIONS

		MS3780	
Operational			
Light Source:	Visible Laser Diode (VLD) @ 650 nm		
Laser Power:	1.1 mW (Peak)		
Normal Depth of Field:	25 mm - 280 mm (1" - 11")	0.33 mm (13 mil) bar code	
Reduced Depth of Field:	25 mm - 150 mm (1" - 6")		
<i>Omni Scan</i>			
	Scan Speed:	1333 scan lines per second	
	No. of Scan Lines:	20	
<i>Single-Line</i>			
	Scan Speed:	67 scan lines per second	
	No. of Scan Lines:	1	
	Motor Speed:	4000 RPM	
	Min Bar Width:	0.127 mm (5.0 mil)	
	Decode Capability:	All standard 1-D bar codes including RSS-14, RSS-Expanded, and RSS-14 Limited	
	System Interfaces:	RS232, Keyboard Wedge, Stand-Alone Keyboard, Light Pen Emulation, IBM468x/469x, USB (low speed and full speed), OCIA	
	Print Contrast:	35% minimum reflectance difference	
	No. Characters Read:	Up to 80 data characters Maximum number will vary based on symbology and density.	
	Beeper Operation:	7 tones or no beep	
	Indicators (LED):	Blue = laser on, ready to scan	
		White = good read, decoding	
	Termination:	10 position modular RJ45 connector	
	Cable:	Application Dependent	
Mechanical			
	Scanner Length:	189 mm (7.44")	
	Scanner Width:	65 mm (2.56")	
	Scanner Height:	73 mm (2.88")	
	Scanner Weight:	195 g (6.9 oz.)	

Specifications subject to change without notice.

DESIGN SPECIFICATIONS

MS3780	
Electrical	
Voltage Supply:	5VDC \pm 0.25V
Operating Power:	1.375 W
Standby Power:	1.0 W
Operating Current:	275 mA typical at 5VDC
Standby Current:	200 mA typical at 5VDC
DC Transformers:	Class II; 5.2VDC @ 650 mA
Laser Class 1:	IEC 60825-1:1993+A1:1997+A2:2001 EN 60825-1:1994+A11:1996+A2:2001
EMC:	FCC, ICES-003 & EN 55022 Class A
Environmental	
Operating Temperature:	-20°C to 40°C (-4°F to 104°F)
Storage Temperature:	-40°C to 60°C (-40°F to 140°F)
Humidity:	5% to 95% relative humidity, non-condensing
Contaminants:	Sealed to resist airborne particulate contaminants
Ventilation:	None required
Shock:	Withstands multiple drops from 1.5 meters

Specifications subject to change without notice.

APPLICATIONS AND PROTOCOLS

The model number on each scanner includes the scanner number and factory default communications protocol.

SCANNER	VERSION IDENTIFIER	INTERFACE
MS3780	9	OCIA and RS232 Transmit/Receive
	11	IBM 46xx and Full RS232
	38	RS232 Low Speed USB*, Keyboard Emulation or USB Serial Emulation Mode
	40	Full Speed USB
	41	RS232/Light Pen Emulation
	47	Keyboard Wedge, Stand-Alone Keyboard and RS232 Transmit/Receive
	48	Stand Alone Keyboard and RS232 Transmit/Receive

The MS3780 scanner with Built-in PC Keyboard Wedge Interface is designed to be used for keyboard emulation only. Many RS232 configurable functions (e.g. formatting) available in other Metrologic scanners are also available as keyboard wedge functions.

The following are the most important selectable options specific to the keyboard wedge.

Keyboard Type

- ** AT (includes IBM® PS2 models 50, 55, 60, 80)
- XT
- IBM PS2 (includes models 30, 70, 8556)

Keyboard Country Type

- USA **
- Belgium
- French
- German
- Italian
- Japan
- Spanish
- Swiss
- United Kingdom

** Default setting. For a complete list of default settings, see *Default Settings - Communication Parameters* starting on page 30 of this guide. Refer to the MetroSelect® Configuration Guide (MLPN 00-02407) or MetroSet2's help files for information on how to change the default settings.

DEFAULT SETTINGS - COMMUNICATION PARAMETERS

Many functions of the scanner can be "configured" - that is enabled or disabled. The scanner is shipped from the factory configured to a set of default conditions. The default parameter of the scanner has an asterisk (*) in the charts on the following pages. If an asterisk is not in the default column then the default setting is *off* or *disabled*. Every interface does not support every parameter. If the interface supports a parameter listed in the charts on the following pages, a check mark (✓) will appear in the column for that interface.

PARAMETER	DEFAULT	OCIA	USB	RS232*	LIGHT PEN	IBM 46XX	KBW
UPC/EAN	*	✓	✓	✓	✓	✓	✓
Code 128	*	✓	✓	✓	✓	✓	✓
Code 93	*	✓	✓	✓	✓	✓	✓
Codabar	*	✓	✓	✓	✓	✓	✓
Interleaved 2 of 5 (ITF)	*	✓	✓	✓	✓	✓	✓
MOD 10 Check on ITF		✓	✓	✓	✓	✓	✓
Code 11		✓	✓	✓	✓	✓	✓
Code 39	*	✓	✓	✓	✓	✓	✓
Full ASCII Code 39		✓	✓	✓	✓	✓	✓
MOD 43 Check on Code 39		✓	✓	✓	✓	✓	✓
MSI-Plessey		✓	✓	✓	✓	✓	✓
MSI-Plessey 10/10 Check Digit		✓	✓	✓	✓	✓	✓
MSI-Plessey MOD 10 Check Digit		✓	✓	✓	✓	✓	✓
Paraf Support		✓	✓	✓	✓	✓	✓
ITF Symbol Lengths	Variable	✓	✓	✓	✓	✓	✓
Minimum Symbol Length	4	✓	✓	✓	✓	✓	✓
Symbol Length Lock	None	✓	✓	✓	✓	✓	✓
RSS14 Enable		✓	✓	✓	✓	✓	✓
RSS14 ID "Je0"	*	✓	✓	✓	✓	✓	✓
RSS14 App ID "01"	*	✓	✓	✓	✓	✓	✓
RSS14 Check Digit	*	✓	✓	✓	✓	✓	✓
RSS Expanded Enable		✓	✓	✓	✓	✓	✓

DEFAULT SETTINGS - COMMUNICATION PARAMETERS

PARAMETER	DEFAULT	OCIA	USB	RS232*	LIGHT PEN	IBM 46XX	KBW
Expanded ID "je0"	*	✓	✓	✓	✓	✓	✓
RSS Limited Enable		✓	✓	✓	✓	✓	✓
RSS Limited ID "je0"	*	✓	✓	✓	✓	✓	✓
RSS Limited App ID "01"	*	✓	✓	✓	✓	✓	✓
RSS Limited Check Digit	*	✓	✓	✓	✓	✓	✓
Bars High as Code 39	*				✓		
Spaces High as Code 39					✓		
Bars High as Scanned					✓		
Spaces High as Scanned					✓		
DTS/SIEMENS		✓					
DTS/NIXDORF	*	✓					
NCR F		✓					
NCR S		✓					
Poll Light Pen Source					✓		
Beeper Tone	Normal	✓	✓	✓	✓	✓	✓
Beep/Transmit Sequence	Before Transmit	✓	✓	✓	✓	✓	✓
Communication Timeout	None	✓	✓	✓	✓	✓	✓
Razberry Tone on Timeout		✓	✓	✓	✓	✓	✓
Three Beeps on Timeout		✓	✓	✓	✓	✓	✓
No Beeps on Timeout	*	✓	✓	✓	✓	✓	✓
Enter Power Save Mode	5 mins.	✓	✓	✓	✓	✓	✓
Same Symbol Rescan Timeout: 500 msec Programmable in 50 msec steps (MAX 6.35 seconds)	*	✓	✓	✓	✓	✓	✓
Intercharacter Delay Programmable in 1 msec steps (MAX 255 msec)	1 msec 10 msec in KBW	✓	✓	✓		✓	✓
Number of Scan Buffers	1	✓	✓	✓	✓	✓	✓

DEFAULT SETTINGS - COMMUNICATION PARAMETERS

PARAMETER	DEFAULT	OCIA	USB	RS232*	LIGHT PEN	IBM 46XX	KBW
Transmit UPC-A Check Digit	*	✓	✓	✓	✓	✓	✓
Transmit UPC-E Check Digit			✓	✓	✓	✓	✓
Expand UPC-E		✓	✓	✓	✓	✓	✓
Convert UPC-A to EAN-13		✓	✓	✓		✓	✓
Transmit Lead Zero on UPC-E		✓	✓	✓	✓	✓	✓
Convert EAN-8 to EAN-13		✓	✓	✓		✓	✓
Transmit UPC-A Number System	*	✓	✓	✓	✓	✓	✓
Transmit UPC-A Manufacturer ID#	*	✓	✓	✓	✓	✓	✓
Transmit UPC-A Item ID#	*	✓	✓	✓	✓	✓	✓
Transmit Codabar Start/Stop Characters		✓	✓	✓		✓	✓
CLSI Editing (Enable)		✓	✓	✓		✓	✓
Transmit Mod 43 Check Digit on Code 39		✓	✓	✓		✓	✓
Transmit Code 39 Stop/Start Characters		✓	✓	✓		✓	✓
Transmit Mod 10/ITF		✓	✓	✓		✓	✓
Transmit MSI-Plessey Check Characters		✓	✓	✓		✓	✓
Parity	Space			✓			
Baud Rate	9600			✓			
8 Data Bits				✓			
7 Data Bits	*			✓			
Stop Bits	2			✓			
Transmit Sanyo ID Characters			✓	✓			✓

DEFAULT SETTINGS - COMMUNICATION PARAMETERS

PARAMETER	DEFAULT	OCIA	USB	RS232*	LIGHT PEN	IBM 46XX	KBW
Nixdorf ID			✓	✓			✓
LRC Enabled			✓	✓			✓
UPC Prefix			✓	✓			✓
UPC Suffix			✓	✓			✓
Transmit AIM ID Characters			✓	✓			✓
STX Prefix			✓	✓			✓
ETX Suffix			✓	✓			✓
Carriage Return	*		✓	✓			✓
Line Feed - disabled by default in KBW	*		✓	✓			✓
Tab Prefix			✓	✓			✓
Tab Suffix			✓	✓			✓
“DE” Disable Command				✓			
“FL” Laser Enable Command				✓			
DTR Handshaking Support				✓			
RTS/CTS Handshaking				✓			
Character RTS/CTS	*			✓			
Message RTS/CTS				✓			
XON/XOFF Handshaking				✓			
ACK/NAK				✓			
Two Digit Supplements		✓	✓	✓	as code 39	✓	✓
Five Digit Supplements		✓	✓	✓	as code 39	✓	✓
Bookland		✓	✓	✓	as code 39	✓	✓
977 (2 digit) Supplemental Requirement		✓	✓	✓	✓	✓	✓

DEFAULT SETTINGS - COMMUNICATION PARAMETERS

PARAMETER	DEFAULT	OCIA	USB	RS232*	LIGHT PEN	IBM 46XX	KBW
Supplements are not Required	*	✓	✓	✓	✓	✓	✓
Two Digit Redundancy	*	✓	✓	✓	✓	✓	✓
Five Digit Redundancy		✓	✓	✓	✓	✓	✓
100 msec to Find Supplement Programmable in 100msec steps (MAX 800 msec)	*	✓	✓	✓	✓	✓	✓
Coupon Code 128		✓	✓	✓	as code 39	✓	✓
Programmable Code Lengths	7 avail.	✓	✓	✓	✓	✓	✓
Programmable Prefix Characters	10 avail.		✓	✓			✓
Programmable Suffix Characters	10 avail.		✓	✓			✓
Prefixes for individual Code Types			✓	✓			✓
Editing		✓	✓	✓	✓	✓	✓
Inter Scan-Code Delay Programmable (100 µsec steps)	800 µsec						✓
Function/Control Key Support							✓
Minimum Element Width Programmable in 5.6 µsec steps	1 msec				✓		
Normal Depth of Field	*	✓	✓	✓	✓	✓	✓
Reduced Depth of Field		✓	✓	✓	✓	✓	✓

UPGRADING THE FLASH ROM FIRMWARE

The MetroSet2 program is a functional component of Metrologic's new line of Flash- based scanners. This program allows the user of a Metrologic scanner to quickly upgrade to a new or custom version of firmware. It requires the use of a personal computer running Windows® 95 or greater and the use of a serial port. The user merely connects the scanner to a serial port on the PC, launches the MetroSet2 program, and blasts off to new software upgrades.

Each MS3780, regardless of the version number or communication protocol, can be upgraded. In other words, all RS232 (-41), keyboard wedge (-47), light pen (-41), OCIA (-9), IBM 468X/469X (-11), low speed USB (-38), and integrated full speed USB (-40) units can be upgraded. To upgrade all units, a power supply and PowerLink cable (MLPN 54-54014) are required.



RS232 units can be upgraded using the standard PowerLink cable (MLPN 53-53xxx-3).

The program guides the user with its simplistic one click approach. The user must first select the file. Once the file is selected and verified, the scanner is ready to be upgraded. Press the "Flash Scanner" button to upgrade the scanner. The unit will go into a "flash mode" – both the blue and white LEDs will be on. The user can follow the progress of the upgrade by watching the screen for details. When the upgrade is complete, the scanner will respond with its normal one beep on power up. If two beeps occur, the scanner did not upgrade properly. Contact a Metrologic service representative for additional assistance.

Scanner Pinout Connections

The MS3780 scanner interfaces terminate to a 10-pin modular socket. The serial # label indicates the interface enabled when the scanner is shipped from the factory.

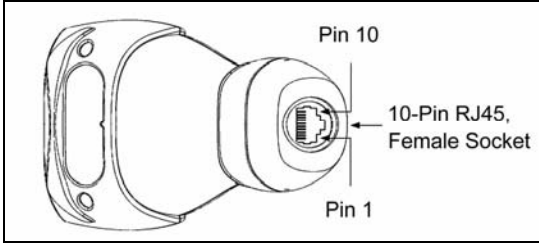

Figure 25.

Keyboard Wedge and Stand-Alone Keyboard MS3780-47	
Pin	Function
1	Ground
2	RS232 Transmit Output
3	RS232 Receive Input
4	PC Data
5	PC Clock
6	KB Clock
7	PC +5V
8	KB Data
9	+5VDC
10	Shield Ground

RS232 and Light Pen Emulation MS3780-41	
Pin	Function
1	Ground
2	RS232 Transmit Output
3	RS232 Receive Input
4	RTS Output
5	CTS Input
6	DTR Input/LTPN Source
7	Reserved
8	LTPN Data
9	+5VDC
10	Shield Ground

MS3780-40 Full Speed USB	
Pin	Function
1	Ground/USB-
2	RS232 Transmit Output
3	RS232 Receive Input
4	RTS Output
5	CTS Input
6	D+
7	USB +V
8	D-
9	+5VDC
10	Shield Ground

RS232 Low Speed USB MS3780-38	
Pin	Function
1	Ground/USB-
2	RS232 Transmit Output
3	RS232 Receive Input
4	RTS Output
5	CTS Input
6	D+
7	USB +V
8	D-
9	+5VDC
10	Shield Ground

Continued on next page.

SCANNER AND CABLE TERMINATIONS

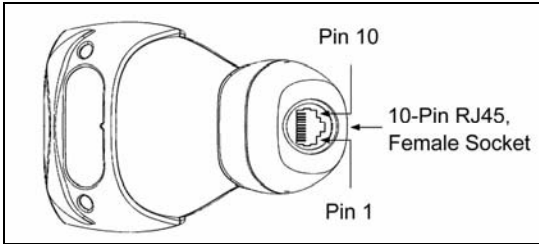

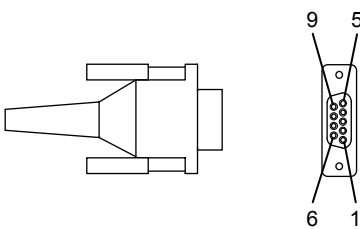

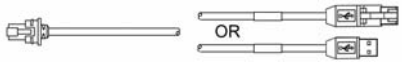

Figure 26.



MS3780-11 IBM 468X/469X	
Pin	Function
1	Ground
2	RS232 Transmit Output
3	RS232 Receive Input
4	RTS Output
5	CTS Input
6	DTR Input
7	IBM B-Transmit
8	IBM A+ Receive
9	+5VDC
10	Shield Ground

MS3780-9 OCIA	
Pin	Function
1	Ground
2	RS232 Transmit Output
3	RS232 Receive Input
4	RDATA
5	RDATA Return
6	Clock In
7	Clock Out
8	Clock in Return/ Clock out Rtrn
9	+5VDC
10	Shield Ground



Cable Connector Configurations (Host End)

RS232 PowerLink Cable 53-53000-3			
Pin	Function	 <p>9-Pin D-Type Connector</p>	
1	Shield Ground		
2	RS232 Transmit Output		
3	RS232 Receive Input		
4	DTR Input/Light Pen Source		
5	Power/Signal Ground		
6	Light Pen Data		
7	CTS Input		
8	RTS Output		
9	+5VDC		



USB Power/Communication Cable 53-53213x-N-3, 53-530214x-N-3 or 53-53235x-N-3			
Pin	Function	 <p>USB Type A Locking with Power</p>  <p>USB Non-Locking</p>	
1	PC +5V/V_USB		
2	D-		
3	D+		
4	Ground		
Shield	Shield		

Stand Alone Keyboard PowerLink Cable 53-53020x-3			
Pin	Function	 <p>6-Pin Male Mini-DIN Connector</p>	
1	PC Data		
2	No Connect		
3	Power Ground		
4	+5VDC PC Power to KB		
5	PC Clock		
6	No Connect		

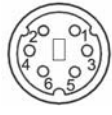
Cable Connector Configurations (Host End)

Keyboard Wedge PowerLink Cable 53-53002x-3		
Pin	Function	 5-Pin DIN, Female
1	Keyboard Clock	
2	Keyboard Data	
3	No Connect	
4	Power Ground	
5	+5 Volts DC	
Pin	Function	 6-Pin DIN, Male
1	PC Data	
2	No Connect	
3	Power Ground	
4	+5 Volts DC	
5	PC Clock	
6	No Connect	

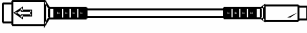
Metrologic will supply an adapter cable with a 5-pin DIN male connector on one end and a 6-pin mini DIN female connector on the other. According to the termination required, connect the appropriate end of the adapter cable to the PowerLink cable, leaving the necessary termination exposed for connecting to the keyboard and the keyboard port on the PC.

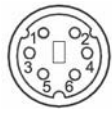
Keyboard Wedge Adapter Cable		
Pin	Function	 5-Pin DIN, Male
1	PC Clock	
2	PC Data	
3	No Connect	
4	Power Ground	
5	+5 Volts DC	
Pin	Function	 6-pin Mini DIN, Female
1	Keyboard Data	
2	No Connect	
3	Power Ground	
4	+5 Volts DC	
5	Keyboard Clock	
6	No Connect	

LASER AND PRODUCT SAFETY

Caution

Use of controls or adjustments or performance of procedures other than those specified herein may result in hazardous laser light exposure. Under no circumstances should the customer attempt to service the laser scanner. Never attempt to look at the laser beam, even if the scanner appears to be nonfunctional. Never open the scanner in an attempt to look into the device. Doing so could result in hazardous laser light exposure. The use of optical instruments with the laser equipment will increase eye hazard.

Atención

La modificación de los procedimientos, o la utilización de controles o ajustes distintos de los especificados aquí, pueden provocar una luz de láser peligrosa. Bajo ninguna circunstancia el usuario deberá realizar el mantenimiento del láser del escáner. Ni intentar mirar al haz del láser incluso cuando este no esté operativo. Tampoco deberá abrir el escáner para examinar el aparato. El hacerlo puede conllevar una exposición peligrosa a la luz de láser. El uso de instrumentos ópticos con el equipo láser puede incrementar el riesgo para la vista.

Attention

L'emploi de commandes, réglages ou procédés autres que ceux décrits ici peut entraîner de graves irradiations. Le client ne doit en aucun cas essayer d'entretenir lui-même le scanner ou le laser. Ne regardez jamais directement le rayon laser, même si vous croyez que le scanner est inactif. N'ouvrez jamais le scanner pour regarder dans l'appareil. Ce faisant, vous vous exposez à une rayonnement laser qui est dangereux. L'emploi d'appareils optiques avec cet équipement laser augmente le risque d'endommagement de la vision.

Achtung

Die Verwendung anderer als der hier beschriebenen Steuerungen, Einstellungen oder Verfahren kann eine gefährliche Laserstrahlung hervorrufen. Der Kunde sollte unter keinen Umständen versuchen, den Laser-Scanner selbst zu warten. Sehen Sie niemals in den Laserstrahl, selbst wenn Sie glauben, daß der Scanner nicht aktiv ist. Öffnen Sie niemals den Scanner, um in das Gerät hineinzusehen. Wenn Sie dies tun, können Sie sich einer gefährlichen Laserstrahlung aussetzen. Der Einsatz optischer Geräte mit dieser Laserausrüstung erhöht das Risiko einer Sehschädigung.

Attenzione

L'utilizzo di sistemi di controllo, di regolazioni o di procedimenti diversi da quelli descritti nel presente Manuale può provocare delle esposizioni a raggi laser rischiose. Il cliente non deve assolutamente tentare di riparare egli stesso lo scanner laser. Non guardate mai il raggio laser, anche se credete che lo scanner non sia attivo. Non aprite mai lo scanner per guardare dentro l'apparecchio. Facendolo potete esporVi ad una esposizione laser rischiosa. L'uso di apparecchi ottici, equipaggiati con raggi laser, aumenta il rischio di danni alla vista.



LASER AND PRODUCT SAFETY

Notices

This equipment has been tested and found to comply with limits for a Class A digital device, pursuant to part 15 of the FCC Rules. These limits are designed to provide reasonable protection against harmful interference when the equipment is operated in a commercial environment. This equipment generates, uses and can radiate radio frequency energy and, if not installed and used in accordance with the instruction manual, may cause harmful interference to radio communications. Operation of this equipment in a residential area is likely to cause harmful interference, in which case the user will be required to correct the interference at their own expense. Any unauthorized changes or modifications to this equipment could void the user's authority to operate this device.

This device complies with part 15 of the FCC Rules. Operation is subject to the following two conditions: (1) This device may not cause harmful interference, and (2) this device must accept any interference received, including interference that may cause undesired operation.

Notice

This Class A digital apparatus complies with Canadian ICES-003.

Remarque

Cet appareil numérique de la classe A, conformément à la norme NMB-003 du Canada.

European Standard

Warning

This is a class A product. In a domestic environment this product may cause radio interference in which case the user may be required to take adequate measures.

Funkstöreigenschaften nach EN 55022:1998

Warnung!

Dies ist eine Einrichtung der Klasse A. Diese Einrichtung kann im Wohnbereich Funkstörungen verursachen; in diesem Fall kann vom Betreiber verlangt werden, angemessene Maßnahmen durchzuführen.

Standard Europeo

Attenzione

Questo è un prodotto di classe A. Se usato in vicinanza di residenze private potrebbe causare interferenze radio che potrebbero richiedere all'utilizzatore opportune misure.

Attention

Ce produit est de classe "A". Dans un environnement domestique, ce produit peut être la cause d'interférences radio. Dans ce cas l'utilisateur peut être amené à prendre les mesures adéquates.

LIMITED WARRANTY

The MS3780 Fusion™ scanners are manufactured by Metrologic at its Blackwood, New Jersey, U.S.A. facility. The MS3780 Fusion scanners have a three (3) year limited warranty from the date of manufacture. Metrologic warrants and represents that all MS3780 Fusion scanners are free of all defects in material, workmanship and design, and have been produced and labeled in compliance with all applicable U.S. Federal, state and local laws, regulations and ordinances pertaining to their production and labeling.

This warranty is limited to repair, replacement of product or refund of product price at the sole discretion of Metrologic. Faulty equipment must be returned to one of the following Metrologic repair facilities: Blackwood, New Jersey, USA; Madrid, Spain; or Suzhou, China. To do this, contact the appropriate Metrologic Customer Service/Repair Department to obtain a Returned Material Authorization (RMA) number.

In the event that it is determined the equipment failure is covered under this warranty, Metrologic shall, at its sole option, repair the Product or replace the Product with a functionally equivalent unit and return such repaired or replaced Product without charge for service or return freight, whether distributor, dealer/reseller, or retail consumer, or refund an amount equal to the original purchase price.

This limited warranty does not extend to any Product which, in the sole judgment of Metrologic, has been subjected to abuse, misuse, neglect, improper installation, or accident, nor any damage due to use or misuse produced from integration of the Product into any mechanical, electrical or computer system. The warranty is void if the case of Product is opened by anyone other than Metrologic's repair department or authorized repair centers.

THIS LIMITED WARRANTY, EXCEPT AS TO TITLE, IS IN LIEU OF ALL OTHER WARRANTIES OR GUARANTEES, EITHER EXPRESS OR IMPLIED, AND SPECIFICALLY EXCLUDES, WITHOUT LIMITATION, WARRANTIES OF MERCHANTABILITY AND FITNESS FOR A PARTICULAR PURPOSE UNDER THE UNIFORM COMMERCIAL CODE, OR ARISING OUT OF CUSTOM OR CONDUCT. THE RIGHTS AND REMEDIES PROVIDED HEREIN ARE EXCLUSIVE AND IN LIEU OF ANY OTHER RIGHTS OR REMEDIES. IN NO EVENT SHALL METROLOGIC BE LIABLE FOR ANY INDIRECT OR CONSEQUENTIAL DAMAGES, INCIDENTAL DAMAGES, DAMAGES TO PERSON OR PROPERTY, OR EFFECT ON BUSINESS OR PROPERTY, OR OTHER DAMAGES OR EXPENSES DUE DIRECTLY OR INDIRECTLY TO THE PRODUCT, EXCEPT AS STATED IN THIS WARRANTY. IN NO EVENT SHALL ANY LIABILITY OF METROLOGIC EXCEED THE ACTUAL AMOUNT PAID TO METROLOGIC FOR THE PRODUCT. METROLOGIC RESERVES THE RIGHT TO MAKE ANY CHANGES TO THE PRODUCT DESCRIBED HEREIN.

WORLDWIDE HEADQUARTERS,

Metrologic Instruments, Inc.
90 Coles Rd.
Blackwood, NJ 08012-4683
Tel: 856-228-8100
Fax: 856-228-6673
Email: info@metrologic.com

METROLOGIC THE AMERICAS HEADQUARTERS

METROLOGIC THE AMERICAS
1571 Imperial Way Suite B
West Deptford, NJ 08066
Tel: 800-ID-METRO (800-436-3876)
Fax: 856-537-6474
Email: info@us.metrologic.com

MTLG AUTO ID INSTRUMENTS (SHANGHAI) CO., LTD

Suzhou Sales Office
BLK A, Room# 03/03-04
No.5 Xinghan Street, Xinsu Industrial Square
China-Singapore
Suahou Industrial Park, Suzhou, PRC
Tel: 86-512-67622550
Fax: 86-512-67622560
Email: info@cn.metrologic.com

METROLOGIC EUROPEAN REPAIR CENTER (MERC)

Metrologic Eria Ibérica, SL
Julian Camarillo 29, D-1
28037 Madrid
Tel: +34 913 272 400
Fax: +34 913 273 829
Email: info@es.metrologic.com

PATENTS

Patent Information

This METROLOGIC product may be covered by one or more of the following U.S. Patents:

U.S. Patent No.;

5,216,232; 5,260,553; 5,340,971; 5,340,973; 5,424,525; 5,468,951;
5,484,992; 5,525,789; 5,528,024; 5,557,093; 5,591,953; 5,616,908;
5,627,359; 5,637,852; 5,661,292; 5,767,501; 5,777,315; 5,789,730;
5,789,731; 5,796,091; 5,811,780; 5,825,012; 5,828,048; 5,844,227;
5,883,375; 5,886,337; 5,895,907; 5,925,870; 5,925,871; 5,939,698;
5,942,743; 6,029,894; 6,098,885; 6,182,898; 6,189,793; 6,286,760;
6,299,067; 6,347,743; 6,412,696; 6,460,767; 6,604,684; 6,856,572;
6,905,071; 6,209,789; 6,860,427

No license right or sublicense is granted, either expressly or by implication, estoppel, or otherwise, under any METROLOGIC or third party intellectual property rights (whether or not such third party rights are licensed to METROLOGIC), including any third party patent listed above, except for an implied license only for the normal intended use of the specific equipment, circuits, and devices represented by or contained in the METROLOGIC products that are physically transferred to the user, and only to the extent of METROLOGIC'S license rights and subject to any conditions, covenants and restrictions therein.

Other worldwide patents pending.

INDEX

A

AC 2, 7–11
Accessories 2, 3
Adapter 9
Audible Indicator.. 15–17, 23–26, 35

B

Bar Code 15–17, 23–26, 27
Bar Width..... 27
Beep..... 15, 16, 17, 23–26, 35
Blue LED 15–17, 23–26, 35
Button 4, 13–14
 CodeGate 4
 Mode Select..... 4

C

Cable
 Communication... 2, 7–11, 23–26,
 35, 38–39
 EAS..... 12
 IBM 2
 Keyboard Wedge 2, 38–39
 OCIA 2
 Pin Assignments 38–39
 PowerLink.. 2, 6, 7–11, 35, 38–39
 RS232..... 2
 Troubleshooting 23–26
 USB 38–39
Caution 5, 7–11, 40
Class 41
CodeGate 1, 4, 13–14
Communication 16, 23–26, 29
 Parameters 30–34
Compliance 7–11
Components 2, 4
Configuration 15, 17
 Default 30–34
Current 28

D

DC 2, 28
Default Settings 13, 29, 30–34
Depth of Field
 Normal 18, 20, 27, 34
 Reduced 19, 20, 21, 27, 34

E

EAS..... 12

F

Failure
 Modes..... 17
FCC 41
Firmware 35
Flash ROM..... 1, 35

H

Host 23–26

I

IBM 8, 30–34
Indicator
 Audible .. 4, 15–17, 23–26, 27, 35
 Failure 17
 Visual 4, 15–17, 23–26, 27, 35
Interface 27
 IBM 1, 8, 30–34
 Keyboard Wedge. 1, 9, 26, 30–34
 Laser Emulation 1, 30–34
 Light Pen 1, 7, 30–34
 OCIA 1, 8, 30–34
 RS232 1, 7, 25, 26, 30–34
 Stand-Alone Keyboard 1, 10
 Troubleshooting..... 23–26
 USB 1, 11, 30–34
IR Activation Range
 Far 22
 Near 22

K

Keyboard..... 29
Keyboard Wedge 9, 26, 30–34

L

Label
 Caution 5
 Serial Number 5
Laser 4, 40
Laser Emulation 30–34
LED 15–17
Light Pen..... 7, 30–34

INDEX

Light Source 27

M

Maintenance..... 6

Manual..... 2, 15, 29

MetroSet2..... 35

Mode of Operation

 Button 14

 Primary 13–14

 Secondary..... 13–14

Mode Select 4

Motor Speed..... 27

Mounting Specifications 5

N

Notices 41

O

OCIA 8, 30–34

Omnidirectional Mode 4

Operation..... 41

P

Patents 43

Pin Assignments

 Cable 38–39

 Scanner 36–37

Port..... 7–11, 23–26

Power 2, 7–11, 35

Power Supply 6

PowerLink..... 7–11

Product Safety..... 40

Protocol 29

R

RAM 25

Razzberry Tone..... 15–17, 25

Read Rate 14

Repair..... 17

ROM..... 25

RS232 7, 25, 26, 30–34

S

Scan Lines 27

Scan Pattern 1, 27

 Primary 13–14

 Secondary 13–14

 Single-Line 13–14

Scan Speed 27

SELV..... 7–11

Single-Line Mode 4

Specification

 Electrical..... 28

 Environmental 28

 Mechanical 27

 Operational..... 27

Stand-Alone Keyboard 10

Storage 28

Switch Bank 12

T

Tone..... 1, 15

Transformer 2, 28

Troubleshooting 23–26

U

Upgrade 35

USB 11, 30–34

V

Ventilation 28

Visual Indicator ... 15–17, 23–26, 35

 Blue LED 4, 23–26

 White LED 4, 23–26

 Amber LED 4, 23–26

Voltage..... 7–11, 28

Volume..... 15

W

Weight..... 27

White LED..... 15–17, 23–26, 35

Window 4

NOTES

Worldwide Headquarters

Metrologic Instruments, Inc.

90 Coles Road • Blackwood, NJ 08012-4683 • Email: info@metrologic.com
Tel: 856-228-8100 • Fax: 856-228-6673 (Sales) • Fax: 856-228-1879 (Marketing) • Fax: 856-228-0653 (Legal/Finance)

Metrologic Companies

Adaptive Optics Associates (AOA)
Tel: 617-806-1400
Fax: 617-806-1899
Email: info@aaoainc.com

Omniplanar
Tel: 856.537.6100
Fax: 856.537.6116
Email: info@omniplanar.com

Metrologic - The Americas

Metrologic The Americas
Tel: 1.856.537.6400
Fax: 1.856.537.6474
Email: info@us.metrologic.com

Metrologic Canada
Tel: 416.752.7190
Fax: 416.752.8060
Email: info@ca.metrologic.com

Metrologic Mexico, S.A. DE C.V.
Tel: 55.5365.6247
Fax: 55.5362.2544
Email: info@mx.metrologic.com

Metrologic do Brasil Ltda.
Tel: 55.11.5182.7273
Fax: 55.11.5182.7198
Email: info@sa.metrologic.com

Metrologic South America
Tel: 239.642.1958
Fax: 239.642.1959
Email: info@sa.metrologic.com

Metrologic GmbH

Metrologic Instruments UK Limited
Tel: +44 (0) 1256 365900
Fax: +44 (0) 1256 365955
Email: info@uk.metrologic.com

Metrologic Instruments GmbH
Tel: 49-89-89019-0
Fax: 49-89-89019-200
Email: info@europe.metrologic.com

Metrologic Eria Iberica, SL
Tel: +34 913 272 400
Fax: +34 913 273 829
Email: info@es.metrologic.com

Metrologic Instruments Italia
Tel: +39 0 57 6511978 or +39 051 651 1978
Fax: +39 0 51 6521337
Email: info@it.metrologic.com

Metrologic Eria France SA
Tel: +33 (0) 1 48 63 78 78
Fax: +33 (0) 1 48 63 24 94
Email: info@fr.metrologic.com

Metrologic Instruments Poland
Tel: +48 (22) 545 04 30
Fax: +48 (22) 545 04 31
Email: info@pl.metrologic.com

Metrologic Russia
Tel: +7 095 730 7424
Fax: +7 095 730 7425
Email: info@ru.metrologic.com

Metrologic Asia (Pte) Ltd

Metrologic Asia (Pte) Ltd
Tel : (65) 6842-7155
Fax : (65) 6842-7166
Email: info@sg.metrologic.com

MTLG Auto ID Instruments (Shanghai) Co., Ltd
Tel: 86-21-58692780
Fax: 86-21-58692782
Email: info@cn.metrologic.com

Suzhou Sales Office
Tel: 86-512-67622550
Fax: 86-512-67622560
Email: info@cn.metrologic.com

Guangzhou Sales Office
Tel: 86-20-38823476
Fax: 86-20-38823477
Email: info@cn.metrologic.com

Chengdu Sales Office
Tel/Fax: 86 28 86200109
Email: info@cn.metrologic.com

Beijing Sales Office
Tel/Fax: 86 10 82253472
Email: info@cn.metrologic.com

India Sales Office
Tel: +91 80 51256718
Fax: +91 80 51256719
Email: info@in.metrologic.com

Metrologic Indonesia
Tel: 62 21 7360682
Fax: 62 21 7360682
Email: a.herdiand@id.metrologic.com

Taiwan Sales Office
Tel: 886-2-2351 0125
Email: john.cheng@tw.metrologic.com

Metrologic Thailand
Tel: 661-814-2352

Metrologic Japan Co., Ltd.
Tel: 81-3-3839-8511
Fax: 81-3-3839-8519
Email: info@jp.metrologic.com

Korea Sales Office
Tel: 82-2-6205-5379
Fax: 82-2-3444-3980
Email: Scott.lee@kr.metrologic.com

November 2005

Printed in the USA



00 - 02269A