

Thermal Label Printer RP80VI

User Manual

Content

Content.....	2
1. Instructions.....	3
1.1 safety warnings	3
1.2 Notices	3
2. SUMMARISATION	4
2.1 Main Features.....	4
3. Technical parameters.....	4
4. Printer installation and operation	6
4.1 The dismantle of the printer	6
4.2 The connection of the printer	6
4.3 The loading of the paper roll.....	7
4.4 Function of Starting Up.....	8
4.4.1 Interval Sensor Adjusting	8
4.4.2 Printer Initializing	9
5. Indicator Light and Button.....	9
5.1 Indicator	9
5.2 Fault Code.....	9
5.3 Button.....	9
6. Printer Serial interface	10
7. Printer parallel interface.....	11
8. Printer Ethernet Port.....	12
9. Printer Cash Drawer Port	13
10. Printer driver	14

1. Instructions

RP80VI series is thermal barcode printer with high performance and reliability. It is with high quality and competitive price and easy to use, so it is widely used in the factory, logistics, restaurant, tea shop, etc.

Safety Notices

Please read the below warnings carefully and observe it strictly before operating the printer.

1.1 safety warnings

Warning: *Do not touch the printer cutter or paper tearing cutter.*

Warning: *The print head is the head and the peripheral comp finishing the printing.*

1.2 Notices

- (1) The printer should be put on solid place. Don't put printer on vibration and shocking place.
- (2) Don't print or save printer in high-temperature, high-humidity and heavily polluted place.
- (3) Printer adapter should be connected to a properly grounded socket. Don't use the same socket together with large motors or other equipment that may cause voltage fluctuations.
- (4) Avoid water or conductive material (such metal) going into the inside of the printer, once happen, should turn off the power immediately.
- (5) If long time not uses printers, should disconnect the adapter power.
- (6) Don't disassemble the printer for overhaul or transformation.
- (7) Please only use the adapter, which is together with printer
- (8) To ensure the quality and lifetime of printer, we recommend to use high-quality thermal paper and ribbon.
- (9) Make sure the printer power is turned off when Pull or plug connection lines.
- (10) When Pull or plug power cord, please hold at the cord end, which is marked with arrow (do not pull the soft part of the cord) .

(11) Please keep this manual for reference.

2. SUMMARISATION

2.1 Main Features

- Support thermal paper roll/thermal sticker/thermal label
- 2-6inch/s high printing speed
- Support 2D printing (QRCODE)
- Paper width from 16mm-82mm and easy to use
- Adjustable pressure of the printing head
- Paper automatic checking function
- Modular design to meet different application requirements
- Self-adaptive temperature control
- Low power consumption and low running costs

3. Technical parameters

- Printing method: Direct thermal printing
- Resolution: 203DPI
- Printing width: 80MM (max)
- Printing speed: 150mm/s (max); 127mm/s (normally)
- Memory: DRAM: 8M FLASH: 4M
- Interfaces

USB interface: General USB interface (standard type B).

Serial interface: DB9 female interface, baud rate of 4800bps, 9600bps, 19200bps or 38400bps optional (via DIP switch adjustments), data structures for no parity, 8 data bits, 1 stop bit, supports RTS / CTS and XON / XOFF handshaking meeting.

Ethernet interface: Standard RJ45-8P interface, 10M / 100M adaptive transmission speed, 100M LED indicates network, data communication LED indicator.

Cash drawer port: Standard RJ-11-6P socket, output DC 24V / 1A power supply signal to drive the cash drawer action.

- Different type of interface panel are as following

RP80VI-UP:

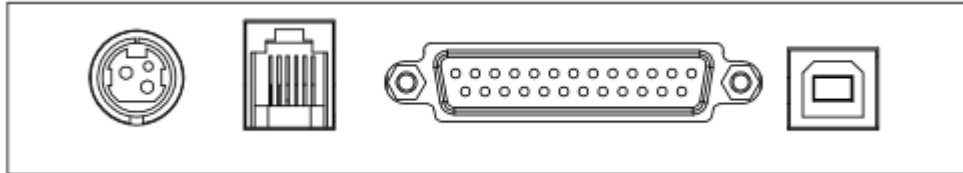

Power port

Cash drawer

Parallel interface

USB

RP80VI-US:



Power port

Cash drawer

Serial interface

USB

RP80VI-USE:

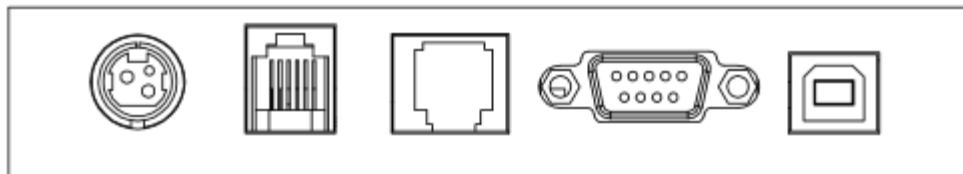

Power port

cash drawer

Ethernet interface

Serial interface

USB

- Barcode:

1D code: CODE128、EAN128、CODE39、CODE93、EAN13、EAN8、CODABAR、UPCA、UPCE、MSI、MSIC、I25

2D code: QRCODE

- Medium

Paper type: thermal paper roll, stickers, etc.

Paper width: 16mm-82mm

Diameter of the outside paper roll: 85mm Max

Paper-out method: automatically stripped or peeled off

- Power adapter of the printer:

Adapter input voltage: AC 110V/220V, 50~60Hz

Adapter output voltage: DC 24V/2.5A

Printer input voltage: DC 24V/2.5A

- Weight of the Printer: 1.36kg (paper roll not included)
- Sizes:
237(L) x 146(W) x 130(H) mm
- Environment:
Working temperature: 5~45 °C; Working humidity:20-80%RH(Non-condensing)
Storage temperature: -40~55 °C; Storage humidity: ≤90%(Non-condensing)

4. Printer installation and operation

4.1 The dismantle of the printer

Check the spare parts

Please check the spare parts when opening the box, please contract the supplier or factory if anything missed.

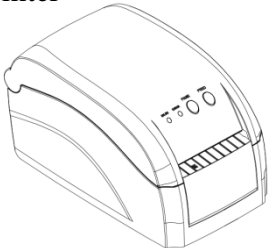
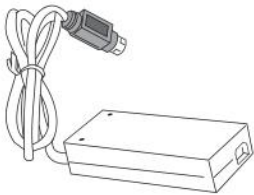
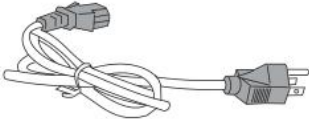
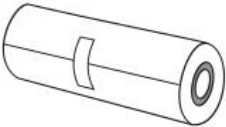
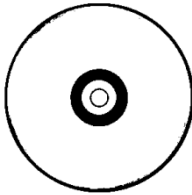
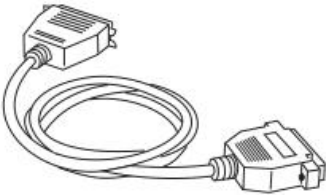
<p>printer</p> 	<p>power adapter</p> 	<p>power cord</p> 
<p>paper roll</p> 	<p>CD</p> 	<p>cable</p> 

4.2 The connection of the printer

(1) Make sure that the printer and PC are turned off, connect the cable to printer and the interface (Serial/Parallel/USB/Ethernet) of the equipment.

(2) If the automatic cash drawer is available, then connect the RJ-11 of the cash drawer to the cash drawer port of the printer.(the specification of the cash drawer must coincide with the driver of the printer's cash drawer)

(3) Connect the dedicated adapter of the printer

Please use the dedicated adapter of the printer. Connection diagram is shown below:

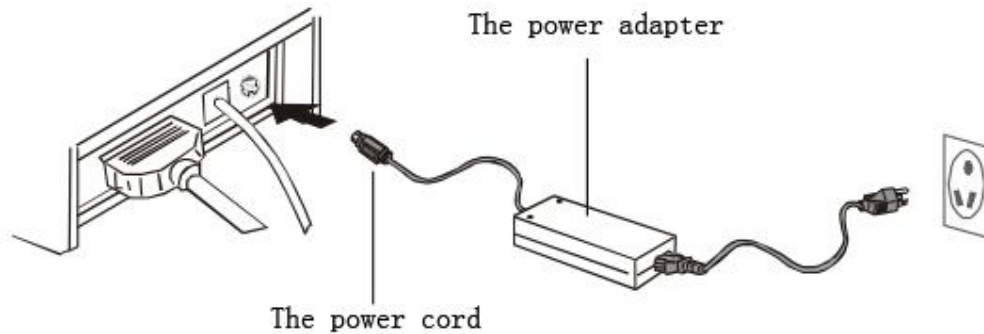

Attention:

- (1) First plug the DC24V power cord of the printer, and then plug the AC220V power, at last turns the power switch. Do not do that opposite way, or it will do harm to the printer.
- (2) Inappropriate use of the power adapter will lead to bad quality printing, or even do harm to the printer.
- (3) Do not connect the telephone line to the cash drawer port, or it will damage both the printer and the telephone.
- (4)When pull the power cord of the printer, please hold the pace where signed arrow (Do not hold the soft cord to pull the power cord). Hold the soft cord and pull may damage the printer or the power adapter.

4.3 The loading of the paper roll

Detailed operation as shown below:

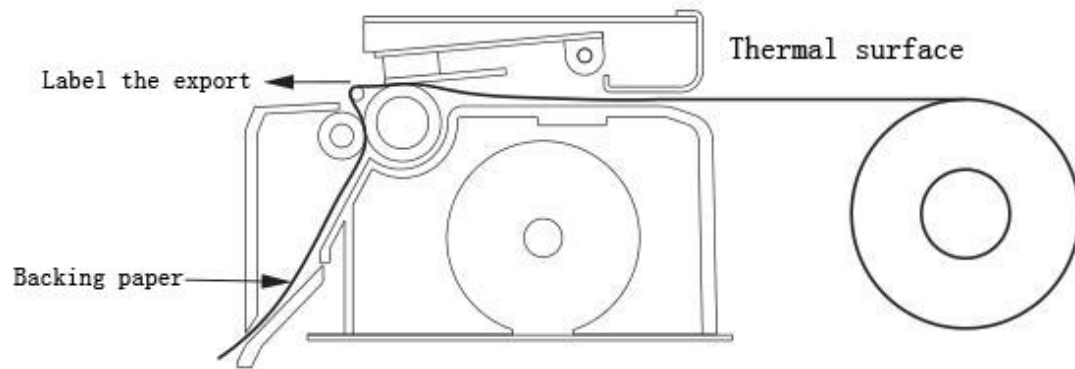

correct



error

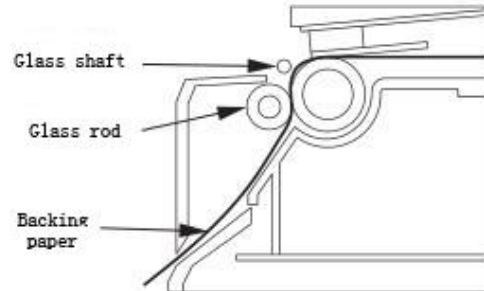
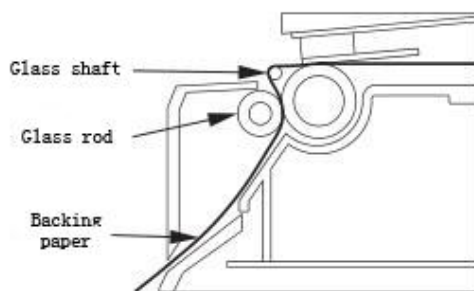

4.4 Function of Starting Up

4.4.1 Interval Sensor Adjusting

It is necessary to adjust sensitivity of interval sensor under the situation below:

1. new printer
2. change label
3. Printer initialization

This function is for testing sensitivity of interval sensor. When users change paper of different specification or initialize printer, it needs to set up the interval sensor adjusting.

Please follow up the steps below to adjust interval sensor:

1. turn off the power of printer
2. make sure the paper exists and cover is closed

- press the *PAUSE* button and turn on the printer, when printer open interval sensor adjustment, loosen *PAUSE* button.

4.4.2 Printer Initializing

This function is for clearing data downloaded in DRAM and resetting the printer. Please start adjustment of interval sensor after initialization.

5. Indicator Light and Button

There is tow indicator lights: blue light for power and red light for error. Tow button: *PAUSE* and *FEED*. Showed as follows:

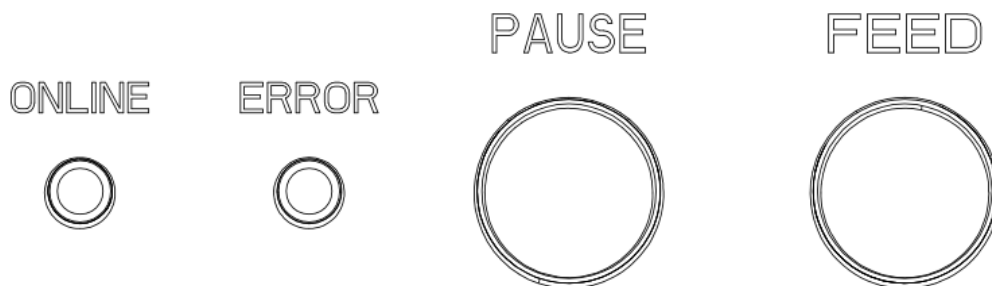

5.1 Indicator

S/N	Status	Function Declaration
1	Power light normally on, error light off	Normal
2	Power light normally on, error light on	Error and refer to fault code

5.2 Fault Code

LED light	Buzzer	Indication
LED light flashes 2 times	Buzzer rings 2 times	Error in mechanism
LED light flashes 3 times	Buzzer rings 3 times	Paper out
LED light flashes 4 times	Buzzer rings 4 times	Error in cutter
LED light flashes 5 times	Buzzer rings 5 times	Overheat
LED light flashes 6 times	Buzzer rings 6 times	Error in opening printer
LED light flashes 7 times	Buzzer rings 7 times	Error in seam mark
LED light flashes 8 times	Buzzer rings 8 times	Error in black mark

LED light flashes 9 times	Buzzer rings 9 times	Failure to find SDRAM
LED light flashes 10 times	Buzzer rings 10 times	Failure to find flash

5.3 Button

Serial No.	Function	Description
1	Feed	While power light is on, and ERROR light is off, when press FEED button, printer can feed to the front of next label paper.
2	Pause	When the printer is working, if press PAUSE button, the printer will stopping working.
3	Gap sensor calibration	1.Close printer power 2.Make sure printer is feed paper and cover the upper cover. 3.Press on PAUSE button, and open printer power, now printer will automatic calibrate the sensitivity of gap sensor and then save the parameters into memory. Finally, loosen PAUSE button.

6. Printer Serial interface

RP80VI Printer Serial interface is RS-232 standard, communication baud rate is 4800bps、9600bps、19200bps or 38400bps optional (you can adjust it by DIP switch),8 data bits, without odd and even number validation, one stop bit, support RTS/CTS and XON/XOFF Handshake Protocol.

Printer serial interface, the definition of each pin function is as follows:

Pin no.	Model name	Signal source	Description
2	TXD	Printer	When use XON/XOFF handshake protocol, printer will send control code XON/XOFF to host.
3	RXD	host	Printer will receive data from host

7	RTS	Printer	The signal response current printer state, Low level shows printer is busy, it can not receive data. While high level shows printer is ready, and it can receive data.
5	GND	-----	Signal Ground
4	DTR	Printer	It is same as RTS signal(PIN 7)

The Connection diagram between printer serial interface and POS host serial interface:

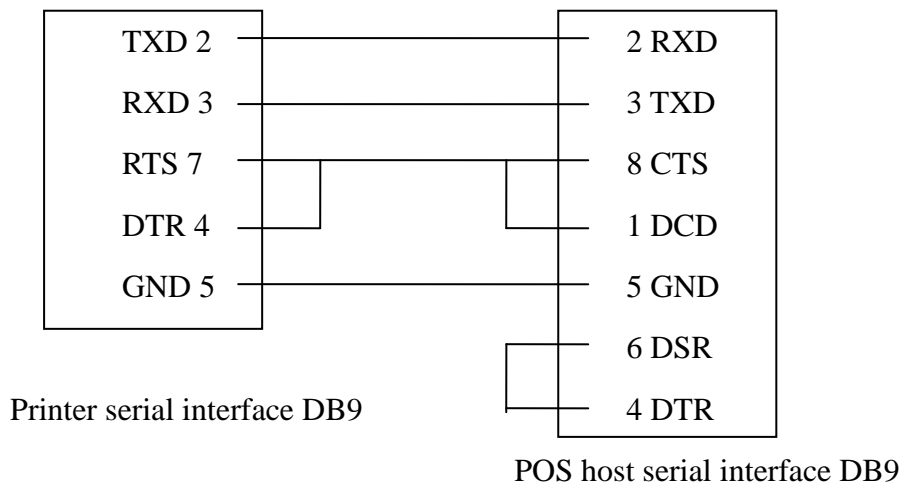

7. Printer parallel interface

RP80VI printer parallel interface socket is 25PIN Parallel socket, 8 bits parallel transmission, support BUSY/nAck handshake protocol. Each PIN function of Printer parallel interface socket is as follows:

PIN no.	Signal name	Signal source	Description
1	/STB	Host	Data gate trigger pulse, it will read-in data when negative edge

2	DATA2	Host	These signals separately represents NO.1 to No.8 information of Parallel data. And when logic is 1, it is high level, when logic is 0, it is low level.
3	DATA3	Host	
4	DATA4	Host	
5	DATA5	Host	
6	DATA6	Host	
7	DATA7	Host	
8	DATA8	Host	
9	DATA9	Host	
10	nAck	Printer	
11	BUSY	Printer	High level shows printer is busy, it can not receive data
12	GND	-----	ground connection, Logic low level
13	Select	Printer	By resistance to pull high level
18-25	GND	-----	Ground connection, logic low level
15	NError(nFault)	Printer	Printer ERROR signal

8. Printer Ethernet Port

The Ethernet interface socket of RP80VI is RJ45-8P, supporting 10M/100M network, and the transmission speed is adaptive.

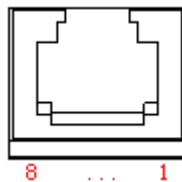

Pin No.	Description	Instruction
1	TX+	Send differential line+
2	TX-	Send differential line -
3	RX+	Receive differential line+
4	NC	No function
5	NC	No function
6	RX-	Receive differential line -
7	NC	No function
8	NC	No function

9. Printer Cash Drawer Port

The printer cash drawer port is with standard RJ-11, 6-wires socket, output DC 24V/1A and work by power signal. Plug the RJ-11 crystal plug into cash drawer port and then you can open the cash drawer via printer.

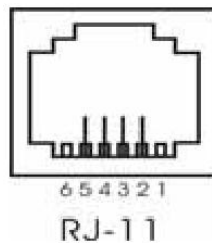

Printer cash drawer interface pin functions are defined as follows:

Pin No.	Signal	Flow Direction
1	Empty	Empty
2	Structure ground	Output
3	Empty	Empty
4	Cash drawer driver signal	Output
5	Empty	Empty
6	Empty	Empty

10. Printer driver

Two types of drive for RP80VI Series: one is to install driver program directly under Windows9x/ ME/ 2000 /XP, the other is to install drive through Serial, Parallel, USB or Ethernet.

(1) Install driver under Windows

Add printer in the Windows, and appoint the driver documents in the driver disk to Windows. It can print once you start print command in the program. In this way, windows printer driver turns characters to graphics dot-matrix for printing.

(2) Install driver by Interface

In this way, no need for drive program. It can print just when it output character to port and the hard font inside printer realizes the character exchange printing. By port for driver, the printing type transforms page printing to line printing, which controls printing more conveniently.